

KUKA SOLAR

A night-time photograph of the Shanghai skyline, featuring the Oriental Pearl Tower and several skyscrapers like the Shanghai Tower and the Shanghai World Financial Center. The image is framed by a large blue circular graphic on the right and an orange rectangular graphic on the left.

**EXPERT IN SOLAR POWER
TRANSMISSION**

KUKA CABLE products have been sold to
more than 120 countries

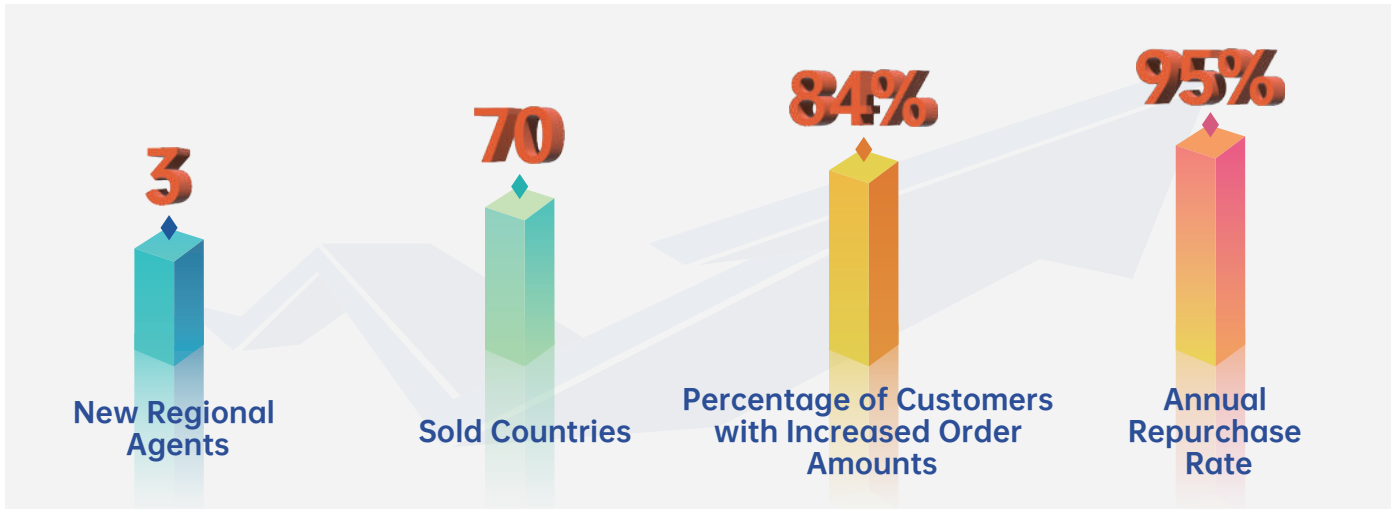

Sales Countries Percentage of Transactional Customers

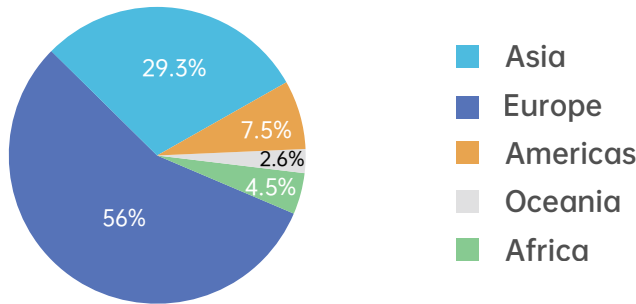

Top 10 Countries by Sales Revenue:

Rank Country

- | | |
|----------------|---------------|
| 1 Germany | 6 UK |
| 2 Pakistan | 7 Netherlands |
| 3 Spain | 8 Australia |
| 4 France | 9 Italy |
| 5 South Africa | 10 Belgium |

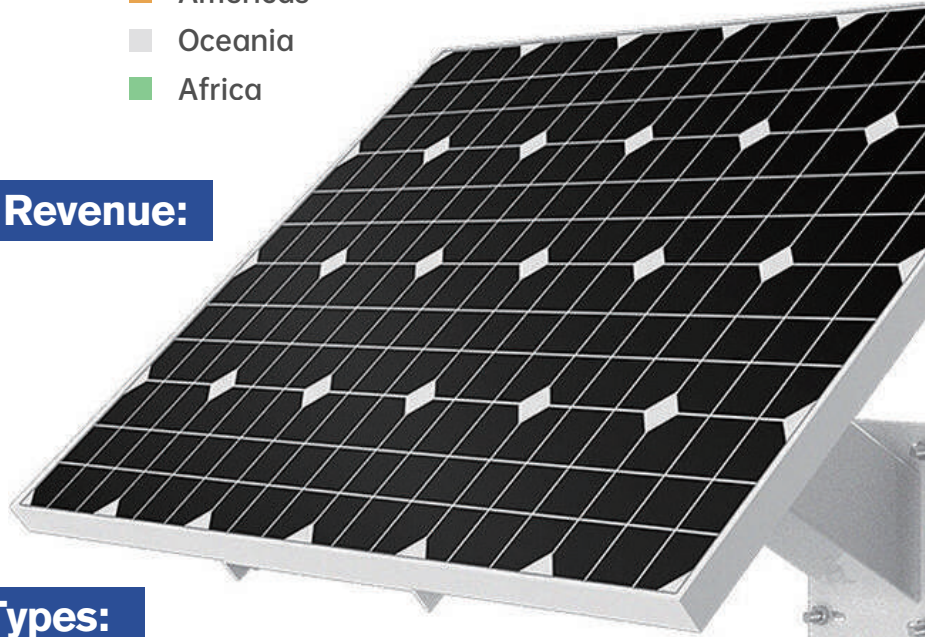

Distribution of Customer Types:

Customer Type Percentage

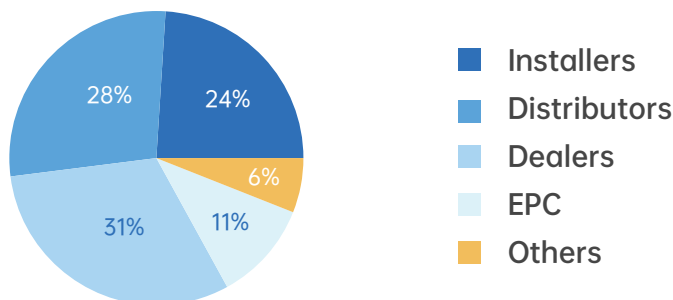

Creating New Opportunities

If you are not yet a customer of KUKA CABLE, we sincerely hope to collaborate with you in the new year as we plan to open up more opportunities to empower your brand and business.

1 Sales plan for 80 countries.

2 Recruitment of regional agents: 5 including:

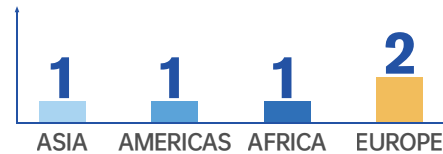

3 Acquisition of 30 new "million-dollar" customers.

Serving Existing Customers

If you are already our customer, we will take concrete actions to provide you with better products and prices, making you more competitive in the end market, and thus establishing a long-term and close cooperative relationship. KUKA CABLE is committed to being your growth "companion."



1. Lower prices

In 2023, KUKA CABLE will continue to optimize its cost structure to provide its cooperative customers with more market-competitive products and prices

- Optimize the entire industry supply chain to negotiate more advantageous raw material prices.
- Upgrade production lines, upgrade "5S" management standards, and further improve efficiency and reduce costs.



2. Stricter quality

KUKA CABLE's new factory will be put into operation in May 2023. The new factory's production capacity will be fully dedicated to the production and manufacturing of photovoltaic series products. The new factory adopts more stringent 5S-level management and manufacturing standards, which are more intelligent, efficient, and can better guarantee product quality



3. Faster delivery times

In 2023, with the commissioning of the new factory building, our delivery efficiency is expected to increase by 40% to 50%, which can meet the delivery requirements of both periodic customers and immediate demand customers.



KUKA CABLE was founded in 2012 and mainly engages in the manufacturing and sales of photovoltaic cables and special cables.

Later, it established a photovoltaic division, focusing on electrical energy transmission products used in photovoltaic installation projects such as photovoltaic cables, connectors, medium-high voltage cables, and mini inverter power lines. Its sales cover major countries such as Europe, Asia, South America, and Africa, and it has exported to more than 120 countries and regions.



SOLD TO MORE THAN 120 COUNTRIES



Factory

More than 5,000 square meters, another new factory of Kuka Cable will be put into use in May 2023.



Laboratory

Leading laboratories can conduct relatively complete tests on materials related to cables and accessories, such as aging tests, wear resistance, water proof, fire tests, etc.

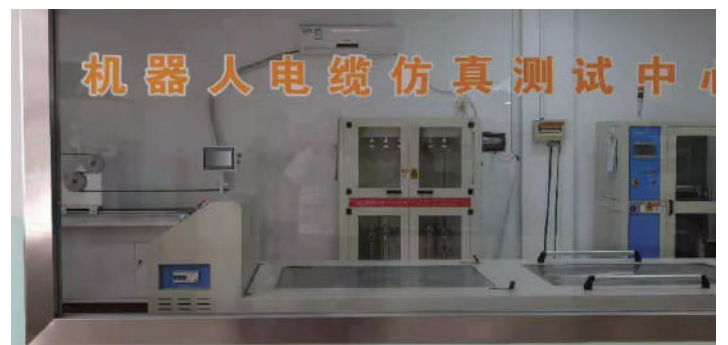
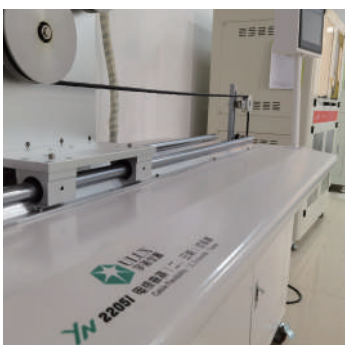

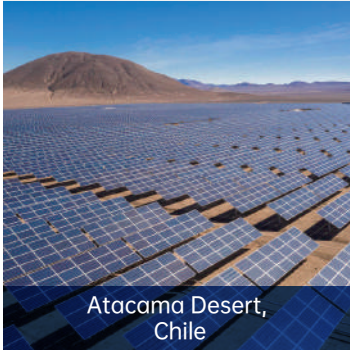

Atacama Desert,
Chile



Bingöl Province,
Türkei



Spanish Agricultural
Photovoltaic Project

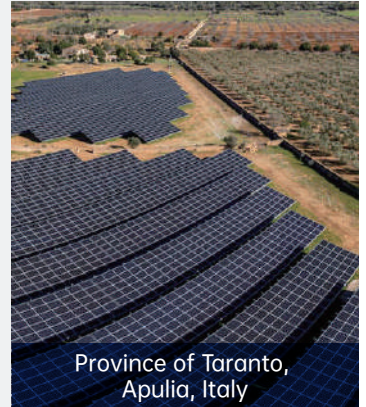

Province of Taranto,
Apulia, Italy



La Serena,
Chile

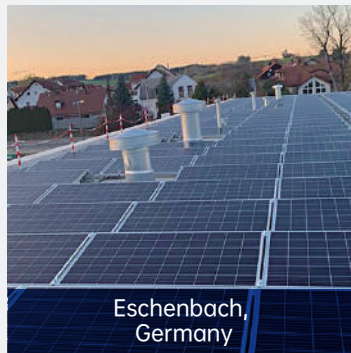

Eschenbach,
Germany

Cases

KUKA CABLE has sold to more than 120 countries
has formed a good product reputation



Customers

Seeing is believing, hearing is deceiving
the choice of thousands of customers

Solar Power Transmission Expert

Product architecture

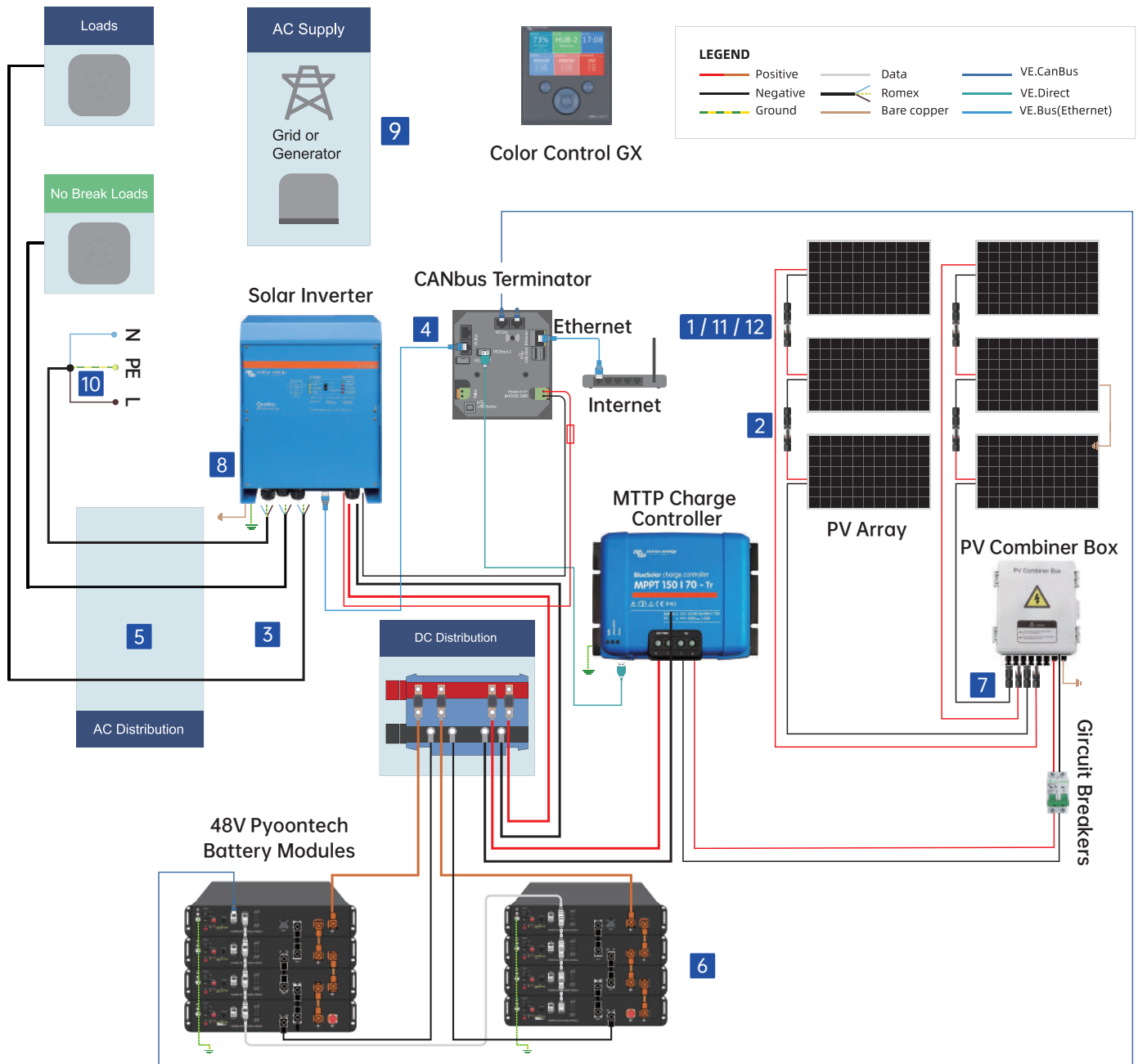

- | | |
|-----------------------------------|---|
| 1 DC Solar Cable | 7 Pre-Assembled PV Cables |
| 2 Solar Connector | 8 Power Cable For Micro-Inverters/Inverters |
| 3 Power Cable | 9 Medium Voltage Cable |
| 4 BUS Cable | 10 Earth Cable |
| 5 Installation Cable | 11 PV Installation Tool Kit |
| 6 Energy Storage Connector | 12 Assembles:cable tie/Protective tube/lock nut... |

Solar Cable

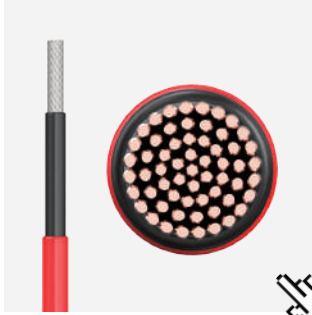

Single Core Solar Cable



Twin Core solar cable

Pre-Assembled PV Cable



Solar Connector



MC4 Connector



T-Branch Connector



Y-Branch Connector

Medium Voltage Cable

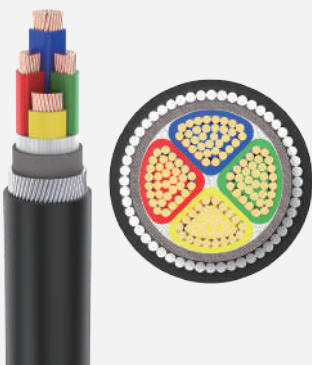

Low Voltage Cable



Miro-Inverter Power Cable



[View More To Website >](#)

Professional Team

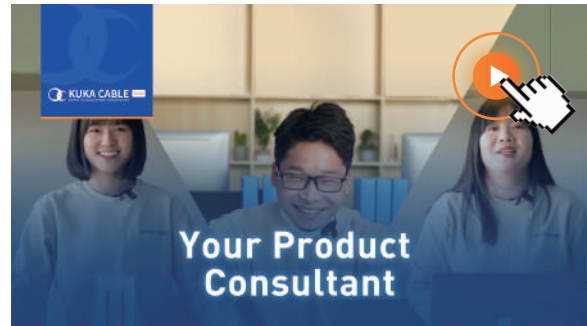

Product Show

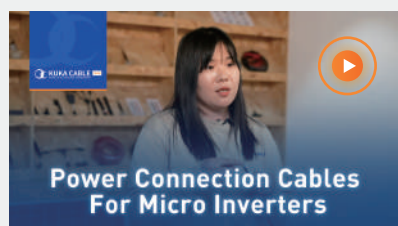
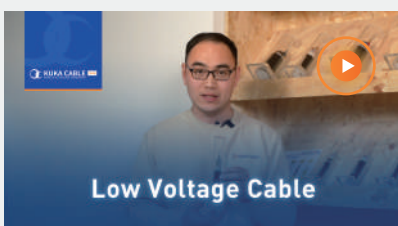
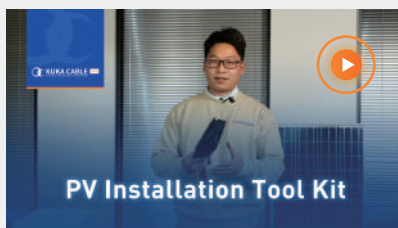
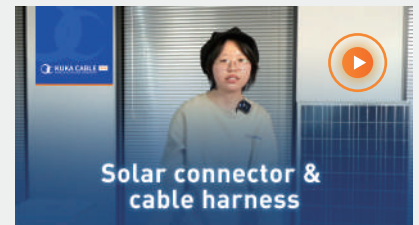

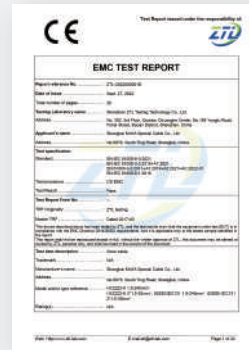

KUKA SOLAR



Shanghai Kuka Special Cable Co, Ltd.

 No. 5878, Tingwei Road, Jinshan District, Shanghai, China

 0086 1831710 9559

 sales@kukacable.com

 www.kukacable.com